

Crawler Excavator

R 920

Litronic®

Motor:
110 kW / 150 HP

Stage IIIA/Tier 3

Operating Weight:
21,000 – 21,500 kg

Bucket Capacity:
0.60 – 1.25 m³



LIEBHERR

R 920 Litronic

Motor:

110 kW / 150 HP
Stage IIIA / Tier 3

Operating Weight:

21,000 – 21,500 kg

Bucket Capacity:

0.60 – 1.25 m³

Performance

Performance, precision
and responsiveness



Efficiency

High level of productivity for a lower overall operating cost

Reliability

Result of ongoing improvements

Comfort

Spacious, ergonomic and with high-visibility

Maintainability

Simplified daily checks, longer maintenance intervals



Performance



**Performance, precision
and responsiveness**

Advanced techniques heighten performance

In its design offices, Liebherr combines the technological know-how of each area to create consistent and optimised integrated systems. Liebherr's electronics, positive control hydraulics, and even the travel motors are designed from the start to be interconnected and generate optimum operating power with fast and fluid movements.

Positive Control hydraulic system

Two working pumps for maximum excavation, travel or swing efficiency, provide power to the components involved. Thanks to the positive control system, the combined movements are optimised for each different work operation, whether this be levelling, extraction, loading or lifting, with or without travel.

Particularly fast work cycles

The work cycles of the R 920 are very fast thanks to the large sized transmission components. For example, the uppercarriage's swing drive can quickly reach its maximum speed with a high swing torque.

Operating pressure

Maximum digging and break-out forces can be reached thanks to the level of hydraulic pressure, without applying temporary overpressure. Maximum forces are therefore guaranteed continuously during the whole working phase to achieve a high level of production. To further improve the machine performances, the equipment speed is optimized through an integrated regeneration circuit.

Engine

- Cummins engine Stage IIIA/Tier 3
- Designed specifically for construction applications
- Automatic fuel-saving idling system
- "Wastegate" turbo for enhanced performances at low speed and reduced consumption



Undercarriage

- Robust design for greater resistance and a better distribution of forces
- Easy and safe transport thanks to integrated lashing eyes



Productivity and flexibility

- Higher digging and break-out forces for increase in productivity
- New optional pads available in 700 and 800 mm for more versatility
- New swing motor for higher swing torque and speed



Efficiency



**High level of productivity for
a lower overall operating cost**

Less fuel

Associated with the latest developments in technology and hydraulics, the tried-and-tested 6-cylinder Cummins engine consumes little fuel, both in terms of hours of operation and in terms of tons of material moved.

Increased productivity

Clearly enhanced performances and low consumption, combined with the largest fuel tank on the market, all in a comfortable and ergonomic work environment, lead to significant increases in productivity in all operating configurations.

Electronic power control

This control system allows the engine power to be effectively and optimally converted, from an energetic point of view, into hydraulic power. This results in greater forces, a faster working speed and a lower fuel consumption.



Liebherr Lubricants

- Liebherr offers you a full range of lubricants and coolants for your Liebherr machines
- Being designed especially for your Liebherr machines, Liebherr lubricants contribute significantly to lowering your operating and maintenance costs

Liebherr tools

- Wide range of tools suitable for every type of application
- Tools designed for maximum productivity and durability
- Shape of buckets designed to assist the filling and stability of bulky materials during the transport stages

Modular quick-change system made by Liebherr

- The suitable digging tool for every application
- The optional quick-change system pays for itself very quickly and your machine becomes a multifunctional tool carrier

Reliability



**Result of ongoing
improvements**

Quality in the smallest details

Robust and large-sized components, optimal fitting of electrical and hydraulic lines, or an exemplary level of finishing are just some of the many criteria that ensure a maximum quality of manufacture and operability.

A top-of-the-range anti-corrosion protection

A pre-assembly painting process guarantees that all painted parts are fully coated. The use of a high-quality paint provides resistance against extreme external conditions.

Perfect match

The individual components of the power train such as the diesel engine, gears, swing drive, working pumps and hydraulic cylinders are specifically dimensioned to work together. This means that they are all compatible with each other in a global system, guaranteeing higher reliability and a longer service life.

Automatic control of functionality

The operator can entirely focus on his job, because the integrated on-board electronic continuously performs a comparison with pre-determined target data. Eventual deviations from the target parameters are shown on the display.

Cummins engine

- Proven reliability
- Service and spare parts available worldwide
- Optimal utilisation even with high sulphur fuel
- Common rail injection system compatible with fuels containing a higher level of sulphur, for a worldwide use
- Bio-diesel compatibility

Key technologies – Made by Liebherr

- Perfect matching of the components to construction machine operations
- The electronic components, mastermind of the machine, are manufactured by Liebherr
- Main steel components, such as undercarriage, equipment modules, and slewing superstructure, all designed by Liebherr

Spare parts service

- Any spare parts required are available worldwide within 24 hours. And that means high operational readiness of the machines, wherever, whenever
- Over 80,000 spare parts in stock at all times



Comfort

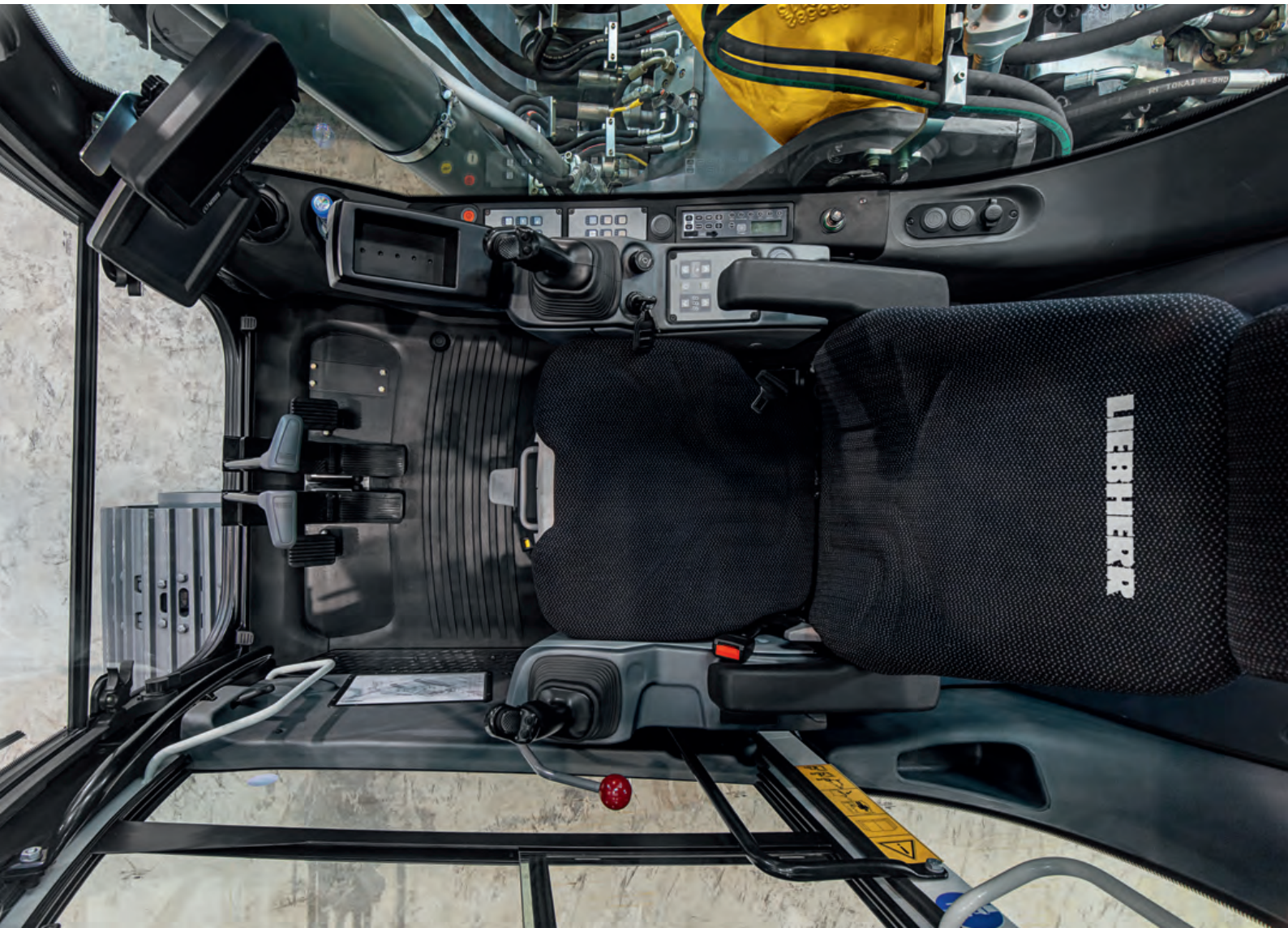

**Spacious, ergonomic
and with high-visibility**

A first class work space

In this cab, the operator benefits from a high-quality mechanical suspension seat, an enlarged space and a very comfortable working environment. Depending on the operator's needs, the "Comfort" seat can be selected as an option. This seat offers maximum comfort thanks to its air suspension, several horizontal and vertical settings, as well as its adjustable pneumatic lumbar support. It is especially designed to meet the most challenging comfort requirements of operators, in all working situations.

Low noise level and vibrations

To diminish fatigue at work and increase productivity, the acoustic power inside the operator's cab is one of the lowest on the market. The cab is mounted on viscoelastic rivets to fully absorb the excavator's vibrations. Furthermore, rubber flanges support the pipes and actively participate in reducing external noise.

Uncompromised visibility

The very large glazed surface area and minimal area of frames guarantee optimal visibility from the operator's platform, as well as a wide emergency exit from the rear window for the operator's safety and peace of mind.

Ergonomic proportional joysticks

The proportional joysticks are very finely tuned controls for the sensitive, accurate and fluid operation of the machine. This type of control is ideal for a machine used in a variety of applications.



Touch-screen display

- 7-inch touch-screen with colour display
- Wide range of adjustment, check, and monitoring possibilities
- Tough, reliable design (sealing tightness class IP 65)

Heightened visibility

- Optional rear view monitoring camera, for optimal visibility and heightened operating safety
- Optimized design of the whole uppercarriage providing the operator with an improved field of vision
- Front windshield fully retractable into the roof, with or without lower glass panel
- Secure emergency exit through the rear window

Optimal temperature

- Enhanced air-conditioning system, providing improved cooling performances
- Optional dark tinted windows

Maintainability



**Simplified daily checks,
longer maintenance intervals**

Ease of maintenance

All the walking areas of the uppercarriage are covered with anti-slip material to guarantee a safe and easy access. The swing gear is greased for life and requires no daily maintenance. The batteries, all filters and most centralized lubrication points are accessible from ground level, ensuring that daily maintenance and checks are quick and easily performed.

Simplified daily checks

The daily checks were taken into account from the start of the design, to make them simpler, more accessible and shorter. The optional automatic lubrication system reduces precious servicing time while guaranteeing optimal lubrication of the excavator.

Longer service intervals

The frequency of the service intervals is optimised to guarantee that each part is operating optimally and that the maintenance operations are only performed as necessary. Whether it is the interval for changing the hydraulic oil, which can be up to 3,000 hours, or the interval for changing the engine oil, every 500 hours, everything has been taken into account to reduce the frequency of interventions and thus limit the machine's downtime and reduce costs.

Expert advice and service provisions

Liebherr offers an expert advice service. Qualified personnel will help you make the appropriate decisions to meet your needs: sales discussion based on the application, service agreements, advantageous repair alternatives, original parts management, and remote data transfer for fleet management.

LiDAT data transfer system

- Complete fleet management, all from one source
- Optimized economical performance of the machine park thanks to detailed view of the distribution of operating states and times
- Reports on capacity commitment and the use of the machine park can be called up daily via the Web portal
- Precise location of the machine
- Regional delimitation and fixed service times increase safety and reliability

Accessibility to service areas

- Access to batteries and filters from ground level
- Access platform to engine oil dipstick

Central lubrication system

- The manual central lubrication system (3 points), fitted as standard, allows for daily lubrication of elements and reduction of machine downtimes
- The optional automatic lubrication system provides only the required amount of grease to the various components and increases their lifetime. It avoids spillage and waste, and quickly pays for itself



Long live progress with the R 920

Equipment

- High digging and breakout forces
- Integrated regeneration circuit
- Fast combined movements
- Cast steel elements
- Greater resistance to stresses
- Longer service life

Tools

- Large standard and HD buckets
- New bucket design
- Z-type Liebherr teeth for fast replacement
- Wide range of work tools

Undercarriage

- Special heat treatment for low wear and tear of drive sprockets
- Robust construction
- Redesigned and strengthened
- New travel motors for increased drawbar pull
- Integrated lashing eyes





Centralized lubrication

- Reduced maintenance time
- Longer service life thanks to better lubrication

Operator's cab

- Comfortable and ergonomic
- New 7" high resolution color touchscreen for heightened readability, easy to use and with more information available
- Large glazed surface area with secure emergency exit through the rear window
- Efficient air conditioning
- European Design

Engine

- Proven reliability
- Extra large fuel tank
- Low fuel consumption
- Longer autonomy
- On-demand hydrostatic driven fan

Uppercarriage

- New swing motor and gearbox for higher swing torque and speed
- Swing gear greased for life
- Steel doors and engine bonnet
- All walking areas covered with anti-slid material
- Ground level access to all filters and batteries
- Optimized design of the whole uppercarriage providing the operator with a better field of vision
- Optional rear view monitoring camera

Technical Data



Engine

Rating per SAE J1995/ISO 3046	110 kW (150 HP) at 1,800 RPM
Model	Cummins QSB 6.7
Type	6 cylinder in-line
Bore/Stroke	107/124 mm
Displacement	6.7 l
Engine operation	4-stroke diesel Common-Rail, turbo
Exhaust gas treatment	emission standard stage IIIA/Tier 3
Cooling system	water-cooled and integrated motor oil cooler, after-cooled and water-cooled
Air cleaner	dry-type air cleaner with pre-cleaner, primary and safety elements
Fuel tank	580 l
Fuel cleaner	pre-filter (7 µm) and fine filter (5 µm) for the fuel supply system
Electrical system	
Voltage	24 V
Batteries	2 x 135 Ah / 12 V
Starter	24 V / 7.8 kW
Alternator	three-phase current 24 V / 70 A
Engine idling	sensor controlled
Motor management	connection to the integrated excavator system controlling via CAN-BUS to the economical utilisation of the service that is available



Hydraulic Controls

The controlling is conducted via the integrated excavator system technology, input and output modules, communicated via the CAN-BUS with the electronic central unit

Power distribution	via control valve with integrated safety valves
Flow summation	to boom and stick
Servo circuit	
Attachment and swing	proportional via joystick levers
Travel	– with proportionally functioning foot pedals and lever – speed pre-selection or automatic adjustment
Additional functions	proportional regulation via foot pedals or rocker



Hydraulic System

Hydraulic system	Positive Control dual circuit hydraulic system for independent and need-based quantity allotment via the hydraulic pumps; sensor-guided. Features high system dynamics and sensibility provided by integrated system controlling
Regeneration	integrated into the main hydraulic block
Hydraulic pump	variable double pump, in-line and swashplate
Max. flow	2 x 216 l/min.
Max. pressure	350 bar
Pump management	electronic pump management via the integrated system controlling (CAN-BUS) synchronous to the control block
Hydraulic tank	100 l
Hydraulic system	max. 300 l
Hydraulic oil filter	1 full flow filter (10 µm)
Cooling system	compact radiator, comprising cooling unit for water, hydraulic oil, after-cooler and hydrostatically driven fan
MODE selection	adjustment of engine and hydraulic performance via a 3-mode selector to match application, e.g. ECO mode for economical and environmentally friendly operation or POWER+ mode for maximum digging performance and heavy-duty jobs
RPM adjustment	stepless adjustment of engine output via RPM at each selected mode
Tool Control	10 preadjustable pump flows and pressures for add-on tools



Swing Drive

Drive	swashplate motor, shockless and antireaction
Transmission	compact planetary reduction gear
Swing ring	sealed race ball bearing swing ring, internal teeth
Swing speed	0 – 11.3 RPM stepless
Swing torque	73.3 kNm
Holding brake	wet multi-disc (spring applied, pressure released)



Operator's Cab

Cab	ROPS (option) safety cab structure with individual windscreens or featuring a slide-in subpart under the ceiling, work headlights integrated in the roof, a door with a side window (can be opened on both sides), large storing possibilities, shock-absorbing suspension, sounddamping insulating, tinted laminated safety glass, separate window shades for the sunroof window and windscreen, 24 V plug, 12 V optional, bottle holder
Operator's seat	Standard seat, air-sprung with mechanic weight adjustment, vertical seat damping including consoles and joysticks. Seat and armrests adjustable separately and in combination
Control system	arm consoles, moving with the seat
Operation and displays	large high-resolution colour display with self-explanatory operation via touchscreen, versatile adjusting, control and monitoring facilities, e.g. implement and tool parameters
Air-conditioning	standard automatic air-conditioning, ambient air function, fast de-icing and demisting at the press of a button, air vents can be operated using special buttons. Filter for recycling and fresh air filter can be replaced and are accessible from the inside. Heating-cooling unit, designed for extreme outside temperatures



Undercarriage

S	gauge 2,250 mm
Drive	Liebherr swashplate motors with integrated brake valves on both sides
Transmission	Liebherr planetary reduction gears
Travel speed	low range – 3 km/h high range – 5 km/h
Net drawbar pull on crawler	228 kN
Track components	B60, maintenance-free
Track rollers / Carrier rollers	7 / 2
Tracks	sealed and greased
Track pads	triple grouser
Holding brake	wet multi-disc (spring applied, pressure released)
Brake valves	integrated into travel motor
Lashing eyes	integrated



Attachment

Type	combination of resistant steel plates and cast steels components
Hydraulic cylinders	cylinders with special seal-system, shock protection
Bearings	sealed, low maintenance
Lubrication	manual central lubrication system or optional automatic central lubrication system (except link and tilt geometry)
Hydraulic connections	pipes and hoses equipped with SAE splitflange connections

Dimensions

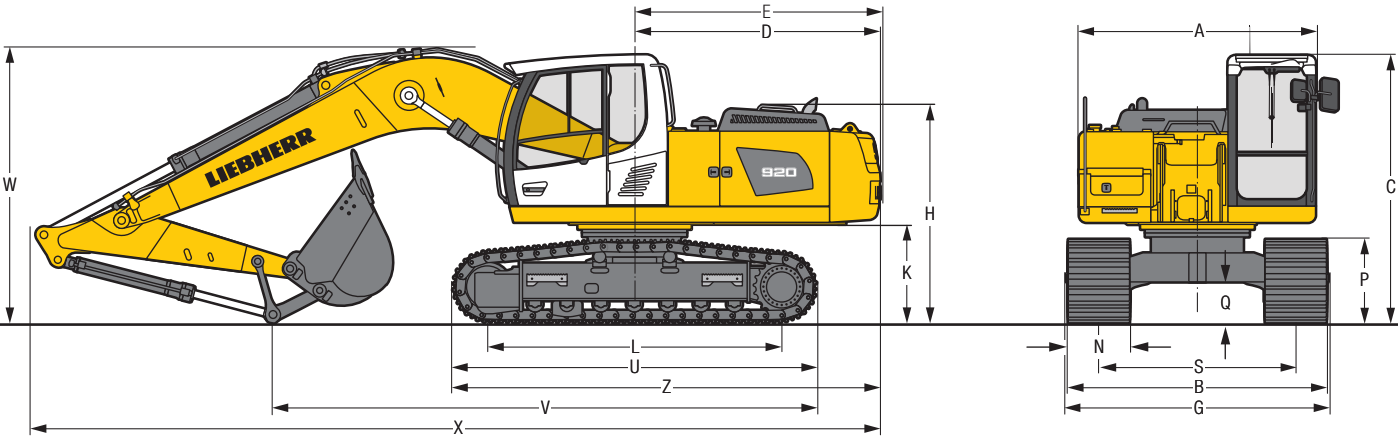

	mm		
A	2,700		
C	3,060		
D	2,800		
E	2,820		
H	2,490		
K	1,125		
L	3,355		
P	960		
Q	465		
S	2,250		
U	4,155		
N	600	700	800
B	2,850	2,950	3,050
G	2,790	2,990*	2,990*
Z	4,880		

* width with removable steps

	Stick length m	Mono boom 5.70 m mm
V	2.00	6,200
	2.50	5,700
	2.90	5,100
W	2.00	3,200
	2.50	3,250
	2.90	3,250
X	2.00	9,750
	2.50	9,750
	2.90	9,750

Backhoe Bucket

with Mono Boom 5.70 m and Counterweight 3.0 t

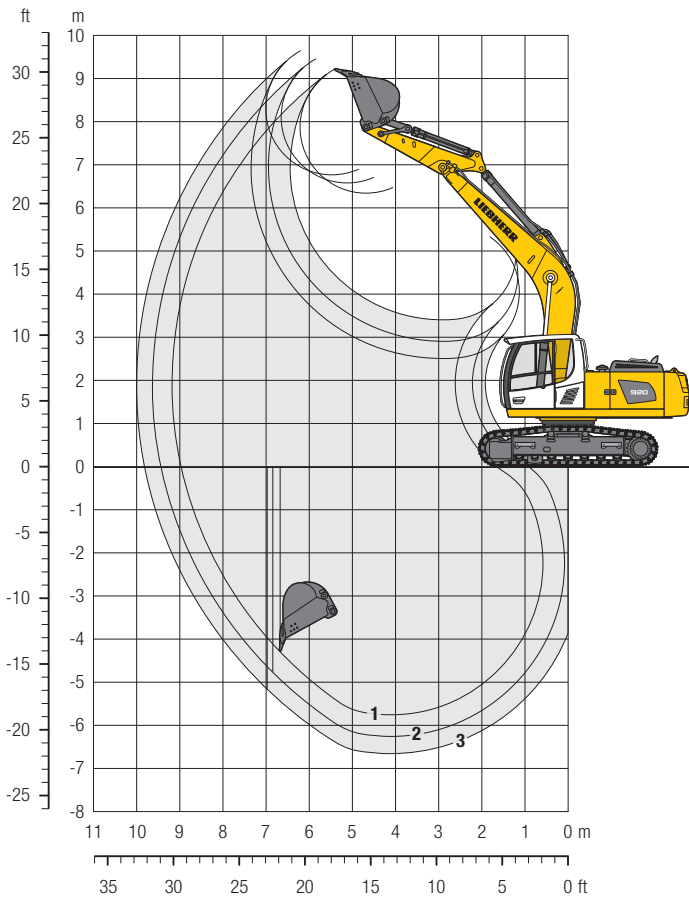

Digging Envelope

		1	2	3
Stick length	m	2.00	2.50	2.90
Max. digging depth	m	5.75	6.25	6.65
Max. reach at ground level	m	8.95	9.45	9.80
Max. dumping height	m	6.35	6.55	6.75
Max. teeth height	m	9.20	9.45	9.65

Digging Forces

		1	2	3
Digging force ISO	kN	146	126	113
	t	14.9	12.8	11.5
Breakout force ISO	kN	157	157	157
	t	16.0	16.0	16.0

Operating Weight and Ground Pressure

The operating weight includes the basic machine with counterweight 3.0 t, mono boom 5.70 m, stick 2.90 m and bucket 0.80 m³ (620 kg).

Undercarriage	S			
Pad width	mm	600	700	800
Weight	kg	21,000	21,250	21,500
Ground pressure	kg/cm ²	0.48	0.42	0.37

Buckets Machine stability per ISO 10567* (75% of tipping capacity)

	Cutting width mm	Capacity ISO 7451 m ³	Weight ⁽³⁾ kg	Weight ⁽⁴⁾ kg	S-Undercarriage					
					Stick length (m)					
					without quick coupler		with quick coupler		with quick coupler	
STD ¹⁾	850	0.60	540	550	2.00	2.50	2.90	2.00	2.50	2.90
	1,050	0.80	620	630	▲	▲	▲	▲	▲	▲
	1,050	0.95	660	670	▲	▲	▲	▲	▲	■
	1,250	1.15	740	750	▲	■	▲	▲	▲	■
	1,250	1.25	850	870	■	▲	■	■	■	△
HD ²⁾	850	0.60	600	610	▲	▲	▲	▲	▲	▲
	1,050	0.80	690	700	▲	▲	▲	▲	▲	▲
	1,050	0.95	750	760	▲	▲	▲	▲	▲	■
	1,250	1.15	840	850	▲	■	■	■	▲	■
	1,250	1.25	970	1,000	■	■	△	▲	△	△

* Indicated loads are based on ISO 10567, at maximum reach, and may be swung 360° on firm and even ground

¹⁾ Standard bucket with teeth Z 35

²⁾ HD bucket with teeth Z 35

³⁾ Bucket for direct mounting

⁴⁾ Bucket for mounting to quick coupler (SW48, 250 kg)

Other backhoes available on request

Max. material weight ▲ = ≤ 2.0 t/m³, ■ = ≤ 1.8 t/m³, ▲ = ≤ 1.65 t/m³, ■ = ≤ 1.5 t/m³, △ = ≤ 1.2 t/m³

Lift Capacities

with Mono Boom 5.70 m and Counterweight 3.0 t

Stick 2.00 m





Stick m	Under- carriage	3.0 m		4.5 m		6.0 m		7.5 m		Max. reach		
		Can be slewed though 360°	In longitudinal position of undercarriage	Can be slewed though 360°	In longitudinal position of undercarriage	Can be slewed though 360°	In longitudinal position of undercarriage	Can be slewed though 360°	In longitudinal position of undercarriage	Max. reach	* Limited by hydr. capacity	Max. reach
7.5	S									5.6	6.5*	5.1
6.0	S					4.4	6.2*			3.9	5.6	6.4
4.5	S			6.5	8.1*	4.2	6.2			3.2	4.6	7.2
3.0	S			5.9	9.2	4.0	5.9	2.9	4.2	2.9	4.2	7.6
1.5	S			5.6	8.8	3.8	5.7	2.8	4.2	2.7	4.1	7.6
0	S			5.4	8.6	3.7	5.6			2.8	4.2	7.4
-1.5	S	10.5*	10.5*	5.5	8.7	3.7	5.6			3.1	4.7	6.8
-3.0	S	10.8	12.8*	5.6	8.8					4.0	6.0	5.8
-4.5	S											

Stick 2.50 m

Stick m	Under- carriage	3.0 m		4.5 m		6.0 m		7.5 m		Max. reach		
		Can be slewed though 360°	In longitudinal position of undercarriage	Can be slewed though 360°	In longitudinal position of undercarriage	Can be slewed though 360°	In longitudinal position of undercarriage	Can be slewed though 360°	In longitudinal position of undercarriage	Max. reach	* Limited by hydr. capacity	Max. reach
7.5	S									4.7	5.8*	5.8
6.0	S					4.4	5.6*			3.4	5.0	7.0
4.5	S			6.6	7.3*	4.2	6.2*	3.0	4.3	2.9	4.2	7.7
3.0	S			6.0	9.3*	4.0	5.9	2.9	4.2	2.6	3.8	8.0
1.5	S			5.6	8.8	3.8	5.7	2.8	4.1	2.5	3.7	8.1
0	S			5.4	8.6	3.6	5.5	2.7	4.0	2.5	3.8	7.9
-1.5	S	9.9*	9.9*	5.4	8.6	3.6	5.5			2.8	4.2	7.3
-3.0	S	10.5	14.0*	5.5	8.7	3.7	5.6			3.4	5.1	6.4
-4.5	S			5.8	7.5*					5.2	6.8*	4.8

Stick 2.90 m

Stick m	Under- carriage	3.0 m		4.5 m		6.0 m		7.5 m		Max. reach		
		Can be slewed though 360°	In longitudinal position of undercarriage	Can be slewed though 360°	In longitudinal position of undercarriage	Can be slewed though 360°	In longitudinal position of undercarriage	Can be slewed though 360°	In longitudinal position of undercarriage	Max. reach	* Limited by hydr. capacity	Max. reach
7.5	S					4.5	5.2*			4.1	5.2*	6.3
6.0	S					4.5	5.2*			3.1	4.5	7.4
4.5	S			6.7*	6.7*	4.3	5.8*	3.0	4.4	2.6	3.9	8.1
3.0	S			6.1	8.6*	4.0	6.0	2.9	4.2	2.4	3.5	8.4
1.5	S			5.6	8.9	3.8	5.7	2.7	4.1	2.3	3.4	8.5
0	S	4.7*	4.7*	5.3	8.5	3.6	5.5	2.7	4.0	2.3	3.5	8.2
-1.5	S	9.4*	9.4*	5.3	8.5	3.5	5.4	2.6	4.0	2.5	3.8	7.7
-3.0	S	10.3	14.9*	5.3	8.6	3.6	5.5			3.0	4.6	6.9
-4.5	S	10.7	11.7*	5.6	8.4*					4.3	6.6	5.4

 Height
  Can be slewed though 360°
  In longitudinal position of undercarriage
  Max. reach
 * Limited by hydr. capacity

The load values are quoted in tons (t) at stick end (without bucket), and may be swung 360° on firm and even ground. Adjacent values are valid for the undercarriage when in the longitudinal position. Capacities are valid for 600 mm wide track pads. Indicated loads are based on ISO 10567 standard and do not exceed 75% of tipping or 87% of hydraulic capacity (indicated via *). Without bucket cylinder, link and lever the lift capacities will increase by 300 kg. Lifting capacity of the excavator is limited by machine stability and hydraulic capacity. According to European Standard, EN 474-5: In the European Union excavators have to be equipped with an overload warning device, a load diagram and automatic safety check valves on hoist cylinders and stick cylinder(s), when they are used for lifting operations which require the use of lifting accessories.

Standard Equipment

Undercarriage

- Lashing eyes
- Sprocket with dirt ejector
- Track guide (one piece per track frame)
- Track pads 600 mm
- Track rollers, lifetime-lubricated
- Tracks, sealed and greased

Uppercarriage

- Anti-slip surfaces
- Engine hood with gas spring opening
- Handrails
- Manual central lubrication system
- Manual main switch
- Storage box, lockable
- Swing brake lock, maintenance-free
- Tool set 33 pieces

Hydraulic System

- Filter with integrated fine filter
- Hydraulic pressure test ports
- Liebherr hydraulic oil
- Positive Control system
- Pressure accumulators for controlled lowering of equipment with engine turned off
- Work mode selector

Engine

- Automatic engine idling
- Common-Rail injection system
- Conform with stage IIIA/Tier 3 emission standard
- Fuel filter and water separator
- Intercooler
- Oil level
- Stepless adjustable engine speed
- Turbo charger

Operator's Cab

- 7" colour multifunction display with touchscreen
- Air conditioning, automatic
- Cigarette lighter and ashtray
- Coat hook
- Cup holder
- Footrest
- Front windshield fully retractable into the roof, with or without lower glass panel
- Fuel consumption indicator on touchscreen
- Headlights (two pieces, Halogen)
- Interior light
- Mechanical hour meters, readable from outside the cab
- MP3 radio
- Operator seat with mechanical damping
- Rain hood over front window opening
- Rearview mirrors
- Rear window emergency exit
- Retractable seat belt 51 mm
- Roll-down sun blind
- Roof window, right window and windshield with safety glass
- Rubber floor mat
- Sliding windows in cab door
- Storage bin
- Storage space
- Tinted windows
- Viscoelastic damping
- Wiper/washer

Attachment

- Boom cylinders oil regeneration
- Headlight on boom (right, Halogen)
- Load valve for hoist cylinders (on distributor)
- Load valve for stick cylinder (on distributor)
- Manual central lubrication system (except connecting link for bucket kinematics)
- Stick cylinder oil regeneration

Non-exhaustive list, please contact us for further information.

Options

Undercarriage

Steps, wide version for 700 mm and 800 mm track pads
Track guides (three pieces per track frame)
Track guides (two pieces per track frame)
Track pads 700 mm, 800 mm

Uppercarriage

Automatic central lubrication system
Diesel refuelling pump (electric)
Electric socket for external start-up aid (24 V)
Fuel anti-theft device
Fuel tank cap lockable with padlock
Rearview mirror on counterweight
Right-hand rearview mirror

Hydraulic System

Liebherr hydraulic oil, adapted for extreme climate conditions

Engine

Air pre-filter with dust trap
Fuel preheating (24 V)

Operator's Cab

Additional front and/or rear cab headlights (Halogen or LED)
Amber beacon
Auxiliary heater (programmable)
Dark tinted windows
Electric socket (12 V)
Emergency stop button in cab
Falling objects protection structure (FOPS)
Front guard protection structure (FGPS)
Front headlights (two pieces, LED)
Handrest for joysticks
Liebherr proportional control (mini-joysticks 2 axis)
Operator seat "Comfort" with pneumatic damping and retractable seat belt
Preparation for LiDAT (Liebherr data transfer system)
Protection guard (front window and/or roof window)
Rear view monitoring camera
ROPS safety cab structure (ISO 12117-2)
Sun visor
Travel alarm

Attachment

Additional headlight on boom (left, Halogen or LED)
Automatic central lubrication system
Bottom protection for boom
Bottom protection for stick
Filter for hydraulic hammer return flow
Headlight on boom (right, LED)
High pressure circuit
Hydraulic or mechanical quick coupler
Liebherr bucket range
Liebherr tooth system
Medium pressure circuit
Overload warning device
Safety check valves for stick cylinder
Safety check valves on hoist cylinders
Tool Control, 10 tool adjustments selectable via display

Non-exhaustive list, please contact us for further information.

Options and/or special attachments, supplied by vendors other than Liebherr, are only to be installed with the knowledge and approval of Liebherr in order to retain warranty.

The Liebherr Group of Companies

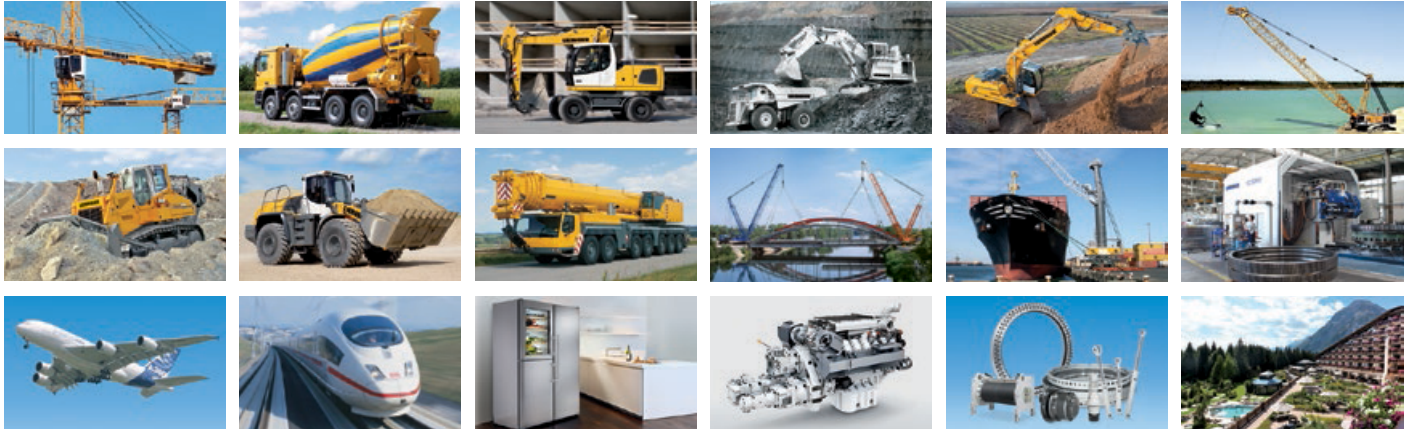

Wide Product Range

The Liebherr Group is one of the largest construction equipment manufacturers in the world. Liebherr's high-value products and services enjoy a high reputation in many other fields. The wide range includes domestic appliances, aerospace and transportation systems, machine tools and maritime cranes.

Exceptional Customer Benefit

Every product line provides a complete range of models in many different versions. With both their technical excellence and acknowledged quality, Liebherr products offer a maximum of customer benefits in practical application.

State-of-the-art Technology

To provide consistent, top quality products, Liebherr attaches great importance to each product area, its components and core technologies. Important modules and components are developed and manufactured in-house, for instance the entire drive and control technology for construction equipment.

Worldwide and Independent

Hans Liebherr founded the Liebherr family company in 1949. Since that time, the enterprise has steadily grown to a group of more than 130 companies with over 41,000 employees located on all continents. The corporate headquarters of the Group is Liebherr-International AG in Bulle, Switzerland. The Liebherr family is the sole owner of the company.

www.liebherr.com