

Crawler excavator

R 976
Litronic®

Operating Weight with Backhoe Attachment:	85,300 – 95,500 kg
Operating Weight with Shovel Attachment:	90,800 – 92,600 kg
Engine Output:	400 kW / 544 HP
Bucket Capacity:	2.00 – 6.60 m ³
Shovel Capacity:	4.40 – 5.60 m ³
Emission standard:	Stage IIIA / Tier 3



LIEBHERR

Equipment

- Cast steel elements
- Greater resistance to stresses
- Longer service life
- Safety check valves for stick and boom cylinders with integrated regeneration for less fuel consumption

Tools

- Different levels of protection to suit the different areas of application
- New Liebherr Z-type tooth system





Operator's cab

- New comfortable and ergonomic design
- 7" high definition colour touch screen
- Wider than the cab in the small excavators range
- Bullet-proof panels at the front and in the roof as standard
- Optional FOPS and FGPS protective guards

Accessibility

- Maintenance platform in the engine compartment
- Broad, anti-slip side catwalks as standard
- Newly designed undercarriage steps for a longer service life

Undercarriage

- Robust structure thanks to the more rigid profile
- Improved self-cleaning capacity
- Molded two-tooth sprocket for a longer service life
- Two types of undercarriage available: an HD fixed-track gauge and LC-V variable-track gauge

Equipment

- Cast steel parts
- Parallel kinematics for powerful and regular digging
- Bucket cylinders positioned under the equipment for better protection against the elements
- Safety valves on boom cylinder for pipe burst protection



Buckets

- The front shovel is the perfect shape for digging deep into the material and for a high filling rate
- Several levels of protection for the front shovel, depending on requirements



Operator's cab

- New comfortable and ergonomic design
- 7" high-resolution colour touch screen
- Wider than the cab in the small excavators range
- Bullet-proof panels at the front and in the roof as standard
- Optional FOPS and FGPS protection guards
- Operator's cab with a fixed riser for a full view over the work area

Technical Data



Engine

Rating per ISO 9249	400 kW (544 HP) at 1,800 RPM
Model	Liebherr D 9508
Type	8 cylinder V-engine
Bore/Stroke	128/157 mm
Displacement	16.16 l
Engine operation	4-stroke diesel common rail injection turbo-charged after-cooled reduced emissions
Cooling	water-cooled
Air cleaner	dry-type air cleaner with pre-cleaner, primary and safety elements
Fuel tank	1,498 l
Electrical system	
Voltage	24 V
Batteries	2 x 180 Ah/12 V
Starter	24 V/7.8 kW
Alternator	three phase current 28 V/100 A



Hydraulic System

Hydraulic pump for attachment and travel drive	two Liebherr variable flow, swash plate pumps
Max. flow	2 x 498 l/min.
Max. pressure	350 bar
Pump regulation	electro-hydraulic with electronic engine speed sensing regulation, pressure compensation, flow compensation, automatic oil flow optimizer
Hydraulic pump for swing drive	reversible, variable flow, swash plate pump, closed-loop circuit
Max. flow	315 l/min.
Max. pressure	350 bar
Hydraulic tank	536 l
Hydraulic system	1,134 l
Hydraulic oil filter	2 full flow filters in return line with integrated fine filter area (5 µm)
Hydraulic oil cooler	compact cooler for water cooler, after-cooler, fuel cooler and transmission pump oil, sandwiched with cooler for oil and condenser of air-conditioning with hydrostatically controlled fan drives
MODE selection	adjustment of engine and hydraulic performance via a mode pre-selector to match application for especially economical and environmentally friendly operation or for maximum digging performance and heavy-duty jobs
RPM adjustment	stepless adjustment of engine output via RPM at each selected mode
Tool Control	10 preadjustable pump flows and pressures for add-on tools



Hydraulic Controls

Power distribution	via control valves in single block with integrated safety valves
Flow summation	to boom and stick
Closed-loop circuit	for uppercarriage swing drive
Servo circuit	electro-hydraulic control
Attachment and swing	proportional via joystick levers
Travel	– proportional via foot pedals or removable hand levers – speed pre-selection
Additional functions	via foot pedals or joystick toggle switch



Swing Drive

Drive by	Liebherr swash plate motor with integrated brake valves
Transmission	Liebherr compact planetary reduction gear
Swing ring	Liebherr, sealed single race ball bearing swing ring, internal teeth
Swing speed	0 – 5.9 RPM stepless
Swing torque	295 kNm
Holding brake	wet multi-disc (spring applied, pressure released)
Option	pedal controlled positioning brake



Operator's Cab

Cab	work headlights integrated in the ceiling, a door with a side window (can be opened on both sides), large stowing and depositing possibilities, shock-absorbing suspension, sounddamping insulating, tinted laminated safety glass, separate window shades for the sunroof window and wind-screen, 12 V plug, storage bins, lunchbox, cup holder
Operator's seat	Liebherr-Comfort seat, airsprung with automatic weight adjustment, vertical and horizontal seat damping including consoles and joysticks. Seat and armrests adjustable separately and in combination, seat heating as standard
Control system	arm consoles, swinging with the seat
Operation and displays	large high resolution colour display with self-explanatory operation via touch screen, video, versatile adjusting, control and monitoring facilities, e.g. climate control, implement and tool parameters
Air-conditioning	standard automatic air-conditioning, ambient air function, fast de-icing and demisting at the press of a button, air vents can be operated via a menu; ambient air and fresh air filters can be easily replaced and are accessible from the outside; heating-cooling unit, designed for extreme outside temperatures, sensors for solar radiation, inside and outside temperatures
Noise emission	
ISO 6396	L_{pA} (inside cab) = 80 dB(A)
2000/14/EC	L_{WA} (surround noise) = 110 dB(A)



Undercarriage

Version	
HD	gauge 3,600 mm
LC-V	gauge 3,590 mm
Drive	Liebherr swash plate motors with integrated brake valves on both sides
Transmission	Liebherr planetary reduction gears
Travel speed	low range – 2.7 km/h high range – 4.3 km/h
Net drawbar pull on crawler	538 kN
Track components	D 9 G, maintenance-free
Track rollers/Carrier rollers	HD: 8/2 LC-V: 9/3
Tracks	sealed and greased
Track pads	double grouser
Digging locks	wet multi-discs (spring applied, pressure released)
Brake valves	outside the travel motor
Lashing eyes	integrated



Attachment

Type	combination of resistant steel plates and cast steel components
Hydraulic cylinders	Liebherr cylinders with special seal-system, shock protection
Pivots	sealed, low maintenance
Lubrication	automatic central lubrication system (except link and tilt geometry)
Hydraulic connections	pipes and hoses equipped with SAE split-flange connections
Bucket	standard equipped with Liebherr tooth system

Dimensions

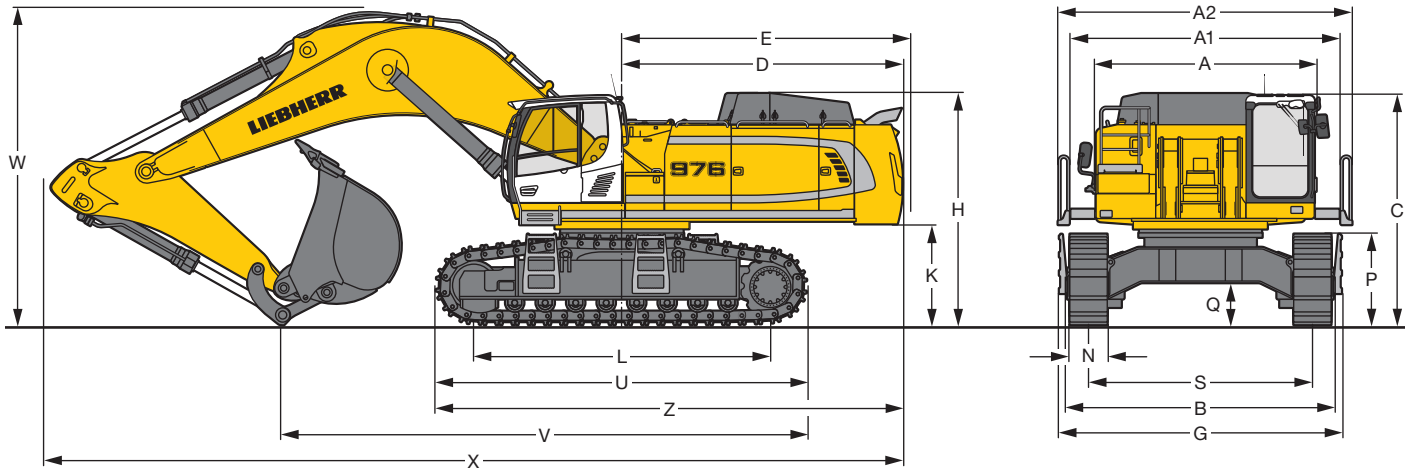

	HD			LC-V		
	mm			mm		
A	3,565			3,565		
A1	4,355			4,355		
A2	4,730			4,730		
C	3,695/3,890*			3,835/4,030*		
D	4,515			4,515		
E	4,640			4,640		
H	3,725			3,865		
K	1,620			1,755		
L	4,770			5,160		
P	1,460			1,495		
Q	682			955		
S	3,600			2,750**/3,590		
U	5,955			6,335		
N	500	600	750	500	600	750
B	4,290	4,290	4,350	3,490**	3,490**	3,500**
G	4,540	4,540	4,540	3,870**	3,870**	3,870**
Z	7,490			7,680		

* with FOPS top guard

** transport position

HD-Undercarriage		
	Stick length	
	m	mm
V	2.90	8,450
	3.30	8,200
W	2.90	5,100
	3.30	5,250
X	2.90	13,800
	3.30	13,500

LC-V-Undercarriage		
	Stick length	
	m	mm
V	2.90	8,600
	3.30	8,350
W	2.90	5,150
	3.30	5,350
X	2.90	13,800
	3.30	13,500

Backhoe Bucket

with Mono Boom 7.20 m

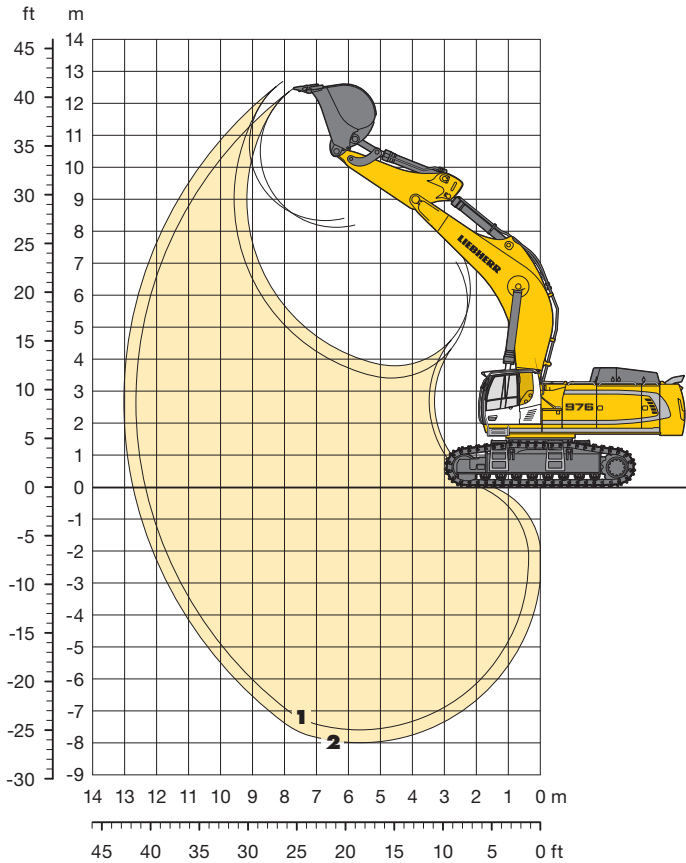

Digging Envelope

		1	2
Stick length	m	2.90	3.30
Max. digging depth	m	7.60	8.00
Max. reach at ground level	m	12.35	12.75
Max. dumping height	m	8.10	8.35
Max. teeth height	m	12.45	12.70
Digging force ISO	kN	390	361
	t	39.8	36.8
Breakout force ISO	kN	485	485
	t	49.4	49.4

Operating Weight and Ground Pressure

The operating weight includes the basic machine with mono boom 7.20 m, stick 2.90 m and bucket 5.20 m³ (4,600 kg).

Undercarriage		HD			LC-V		
Pad width	mm	500	600	750	500	600	750
Weight	kg	85,300	86,000	87,100	90,400	91,200	92,300
Ground pressure	kg/cm ²	1.65	1.38	1.12	1.62	1.36	1.10

Optional: heavy counterweight
(heavy counterweight increases the operating weight by 1,900 kg and ground pressure by 0.04 kg/cm²)

Buckets Machine stability per ISO 10567* (75% of tipping capacity)

Cutting width mm	Capacity ISO 7451 m ³	Weight kg	HD-Undercarriage		LC-V-Undercarriage	
			Stick length (m)		Stick length (m)	
			2.90	3.30	2.90	3.30
STD ¹⁾	1,800	3.80	4,000	○	○	○
	1,950	4.30	4,200	○	○	○
	2,150	4.80	4,450	○	○	○
	2,300	5.20	4,600	□	□	□
	2,300	5.80	4,800	□	□	□
	2,600	6.60	5,100	△	△	△
HD ²⁾	1,800	3.60	4,400	○	○	○
	1,950	4.10	4,750	○	○	○
	2,150	4.60	5,050	○	○	○
	2,300	5.20	5,400	□	□	□
	2,300	5.60	5,550	□	△	□
	2,400	6.20	5,900	△	△	△
HDV ³⁾	1,950	4.20	5,250	○	○	○
	2,150	4.70	5,550	□	□	□
	2,300	5.20	5,850	□	□	□
	2,300	5.70	6,400	△	△	△

* Indicated loads are based on ISO 10567 max. stick length, lifted 360° on firm

¹⁾ Standard bucket with Liebherr teeth Z 90

²⁾ HD bucket with Liebherr teeth Z 90

³⁾ HDV bucket with Liebherr teeth Z 90













Other backhoes available on request

Max. material weight ○ = ≤ 2.2 t/m³, □ = ≤ 1.8 t/m³, △ = ≤ 1.5 t/m³, ■ = ≤ 1.2 t/m³, ▲ = not authorized













Lift Capacities

with Mono Boom 7.20 m

Stick 2.90 m

↓ ↑ m	Under-carriage	3.0 m		4.5 m		6.0 m		7.5 m		9.0 m		10.5 m		m		
																
10.5	HD													23.7*	23.7*	6.4
	LC-V													23.5*	23.5*	
9.0	HD							21.6*	21.6*					21.3*	21.3*	8.0
	LC-V							21.6*	21.6*					21.2*	21.2*	
7.5	HD							21.8*	21.8*	19.1	20.4*			19.1	20.2*	9.0
	LC-V							21.9*	21.9*	20.0	20.8*			19.7	20.2*	
6.0	HD					27.4*	27.4*	23.3*	23.3*	18.9	21.1*			16.6	19.9*	9.7
	LC-V					27.7*	27.7*	23.5*	23.5*	19.7	21.1*			17.2	19.9*	
4.5	HD					31.5*	31.5*	24.1	25.3*	18.3	22.0*			15.2	19.5	10.1
	LC-V					31.9*	31.9*	25.1	25.5*	19.1	22.0*			15.8	20.3*	
3.0	HD					31.6	35.1*	22.9	27.3*	17.6	22.9			14.4	18.7	10.3
	LC-V					32.9	35.4*	23.9	27.5*	18.4	23.0*			15.1	20.6*	
1.5	HD					30.2	36.9*	22.0	28.6*	17.1	22.3			14.3	18.6	10.2
	LC-V					31.6	37.0*	23.0	28.7*	17.9	23.7*			15.0	20.8*	
0	HD					29.6	36.7*	21.4	28.6	16.7	21.9			14.7	19.2	9.9
	LC-V					31.0	36.6*	22.5	28.8*	17.5	23.5*			15.6	20.9*	
-1.5	HD			38.5*	38.5*	29.5	34.9*	21.3	27.8*	16.6	21.8			15.9	20.8	9.3
	LC-V			40.4*	40.4*	30.9	34.7*	22.3	27.6*	17.5	22.1*			16.9	21.0*	
-3.0	HD	40.6*	40.6*	38.8*	38.8*	29.8	31.3*	21.5	24.8*					18.4	20.6*	8.5
	LC-V	42.5*	42.5*	38.2*	38.2*	30.8*	30.8*	22.6	24.4*					19.6	20.6*	
-4.5	HD			30.4*	30.4*	24.6*	24.6*							19.1*	19.1*	7.1
	LC-V			29.5*	29.5*	23.7*	23.7*							18.9*	18.9*	

Stick 3.30 m

↓ ↑ m	Under-carriage	3.0 m		4.5 m		6.0 m		7.5 m		9.0 m		10.5 m		m		
																
10.5	HD													20.1*	20.1*	7.0
	LC-V													19.9*	19.9*	
9.0	HD							20.3*	20.3*					18.2*	18.2*	8.4
	LC-V							20.3*	20.3*					18.1*	18.1*	
7.5	HD							20.8*	20.8*	19.4	19.8*			17.4*	17.4*	9.4
	LC-V							20.9*	20.9*	19.8*	19.8*			17.3*	17.3*	
6.0	HD					26.0*	26.0*	22.4*	22.4*	19.0	20.3*			15.6	17.1*	10.1
	LC-V					26.3*	26.3*	22.5*	22.5*	19.8	20.3*			16.2	17.1*	
4.5	HD					30.3*	30.3*	24.4	24.5*	18.4	21.3*			14.3	17.3*	10.5
	LC-V					30.6*	30.6*	24.7*	24.7*	19.2	21.4*	15.0	17.4*	15.0	17.4*	
3.0	HD					32.1	34.2*	23.2	26.7*	17.7	22.5*	14.0	18.1	13.7	17.7	10.6
	LC-V					33.4	34.5*	24.1	26.9*	18.5	22.6*	14.7	19.8*	14.4	18.1*	
1.5	HD					30.5	36.5*	22.1	28.3*	17.1	22.3	13.7	17.7	13.5	17.6	10.6
	LC-V					31.8	36.7*	23.1	28.4*	17.9	23.4*	14.4	20.0*	14.2	19.3*	
0	HD					29.7	36.9*	21.5	28.6	16.7	21.9			13.9	18.1	10.3
	LC-V					31.1	36.9*	22.5	28.8*	17.5	23.6*			14.7	20.0*	
-1.5	HD			36.8*	36.8*	29.4	35.6*	21.2	28.2*	16.5	21.7			14.9	19.5	9.7
	LC-V			38.3*	38.3*	30.9	35.4*	22.3	28.0*	17.4	22.6*			15.8	20.2*	
-3.0	HD	36.6*	36.6*	41.2*	41.2*	29.6	32.5*	21.3	25.8*					16.9	20.0*	8.9
	LC-V	38.2*	38.2*	40.7*	40.7*	31.1	32.1*	22.4	25.5*					18.1	20.0*	
-4.5	HD			33.5*	33.5*	26.8*	26.8*	20.1*	20.1*					19.1*	19.1*	7.7
	LC-V			32.7*	32.7*	26.1*	26.1*	19.2*	19.2*					18.9*	18.9*	

 Height
  Can be slewed through 360°
  In longitudinal position of undercarriage
  Max. reach
 * Limited by hydr. capacity

The load values are quoted in tons (t) at stick end (without bucket), and may be swung 360° on firm and even ground. Adjacent values are valid for the undercarriage when in the longitudinal position. Capacities are valid for 600 mm wide double grouser pads. Indicated loads are based on ISO 10567 standard and do not exceed 75 % of tipping or 87 % of hydraulic capacity (indicated via *). Without bucket cylinder, link and lever the lift capacities will increase by 1,300 kg. Lifting capacity of the excavator is limited by machine stability and hydraulic capacity.

According to European Standard, EN 474-5: In the European Union excavators have to be equipped with an overload warning device, a load diagram and automatic safety check valves on hoist cylinders and stick cylinder(s), when they are used for lifting operations which require the use of lifting accessories.

Dimensions Front Shovel

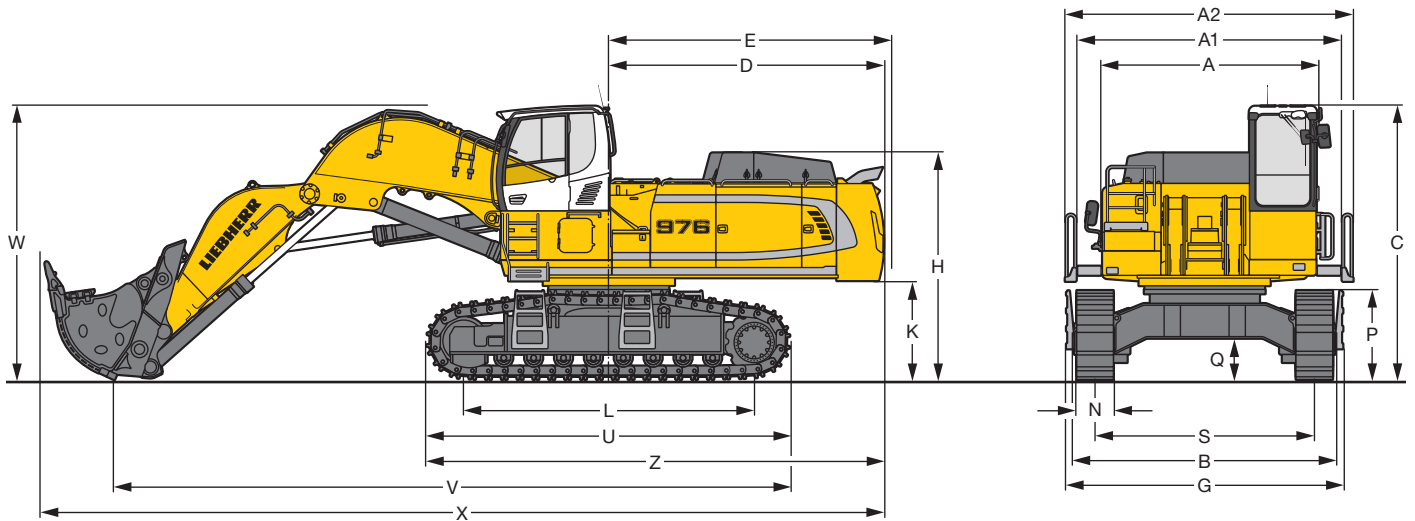

	HD	mm
A		3,565
A1		4,355
A2		4,730
C		4,495/4,690*
D		4,515
E		4,640
H		3,725
K		1,620
L		4,770
P		1,460

	HD	mm
Q		682
S		3,600
U		5,955
N	500 600 750	
B	4,290 4,290 4,350	
G	4,540 4,540 4,540	
Z		7,490
V		11,100
W		4,500
X		13,850

* with FOPS top guard

Front Shovel

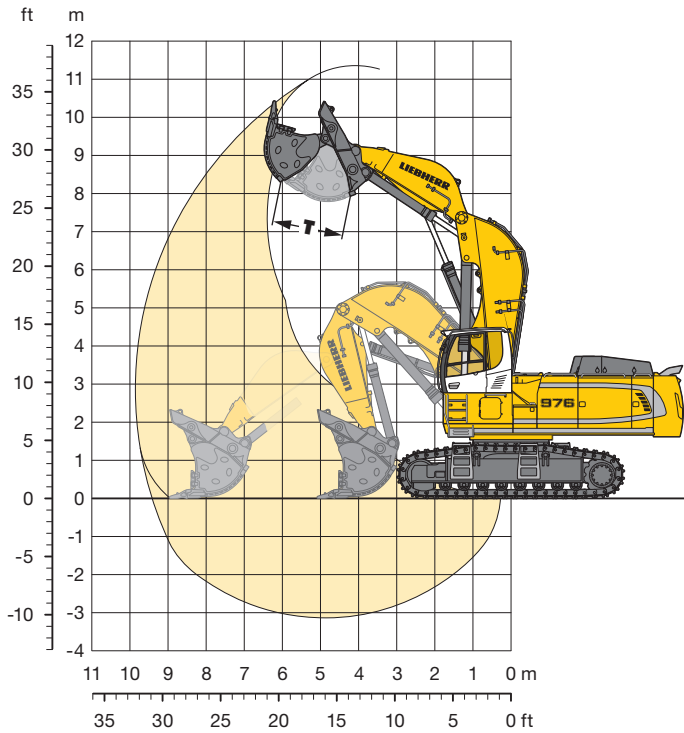

Digging Envelope

Max. reach at ground level	9.40 m
Max. dumping height	7.80 m
Max. crowd length	3.90 m
Bucket opening width T	1,825 mm
Max. crowd force	690 kN/70.4 t
Max. crowd force at ground level	490 kN/50.0 t
Max. breakout force	500 kN/51.0 t

Operating Weight and Ground Pressure

The operating weight includes the basic machine with cab elevation 800 mm, shovel attachment and front shovel 5.10 m³ (9,100 kg), level II.

Undercarriage		HD		
Pad width	mm	500	600	750
Weight	kg	90,800	91,500	92,600
Ground pressure	kg/cm ²	1.75	1.47	1.19

Front Shovels

Cutting width mm	Capacity ISO 7451 m ³	Weight kg	Wear kit level	HD-Undercarriage	
				Shovel Attachment	
2,300	4.40	8,300	II	○	
2,300	4.40	9,150	III	○	
2,700	5.10	8,450	I	□	
2,700	5.10	9,100	II	□	
2,700	5.10	10,150	III	□	
2,700	5.40	9,900	III	△	
2,700	5.60	8,750	I	△	
2,700	5.60	9,450	II	△	

Level I: For non-abrasive materials, such as limestone without flint inclusion, shot material or easily breakable rock, i.e., deteriorated rock, soft limestone, shale, etc.

Level II: For pre-blasted heavy rock, or deteriorated, cracked material (classification 3 to 4, accord. to DIN 18300)

Level III: For highly-abrasive materials such as rock with a high silica content, sandstone etc.

Max. material weight ○ = ≤ 2.2 t/m³, □ = ≤ 1.8 t/m³, △ = ≤ 1.65 t/m³

Component Dimensions and Weights

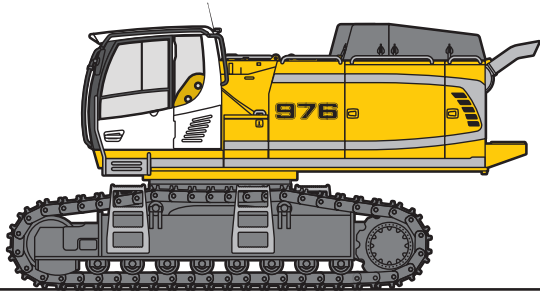

Basic Machine

Track pads	mm	500	600	750
Weight with backhoe attachment and HD-undercarriage	kg	50,500	51,250	52,350
Weight with shovel attachment and HD-undercarriage	kg	50,600	51,350	52,450
Weight with backhoe attachment and LC-V-undercarriage	kg	55,600	56,400	57,550

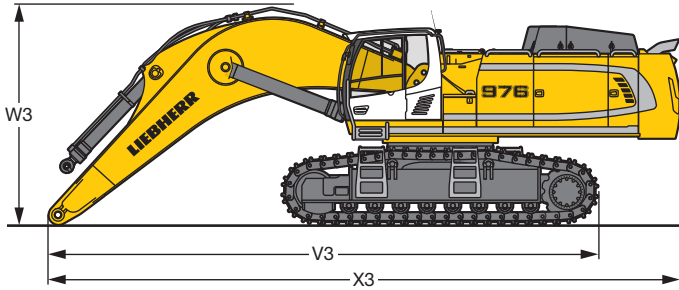

Basic Machine

		HD	LC-V
V3 Mono boom 7.20 m	mm	10,350	10,400
W3 Mono boom 7.20 m	mm	4,150	4,250
X3 Mono boom 7.20 m	mm	11,950	11,900

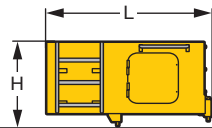

Cab Elevation

		800 mm	
L Length	mm	1,890	
H Height	mm	925	
Width	mm	1,370	
Weight	kg	600	

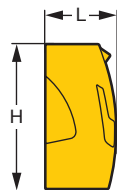

Counterweight

		Std	heavy
L Length	mm	775	775
H Height	mm	1,595	1,595
Width	mm	3,360	3,360
Weight	kg	14,100	16,000

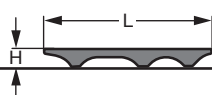

Upper Protection Screen

L Length	mm	1,960
H Height	mm	190
Width	mm	1,110
Weight	kg	75

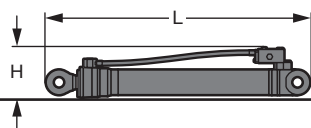

Hoist Cylinders (two)

L Length	mm	2,920
H Height	mm	550
Ø Diameter	mm	400
Weight	kg	2 x 1,050

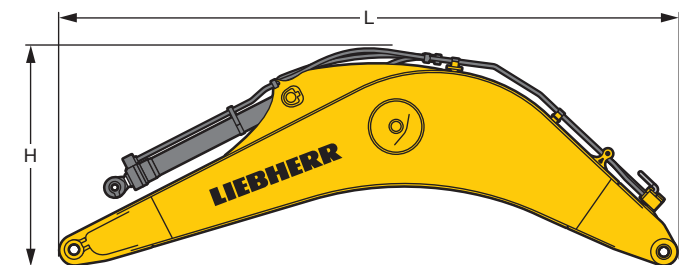

Mono Boom with Stick Cylinder

Stick length	m	7.20
L Length	mm	7,550
H Height	mm	2,700
Width	mm	1,460
Weight	kg	9,500



Stick with Bucket Cylinder

Stick length	m	2.90	3.30
L Length	mm	4,050	4,450
H Height	mm	1,700	1,650
Width	mm	900	900
Weight	kg	4,450	4,550

Component Dimensions and Weights

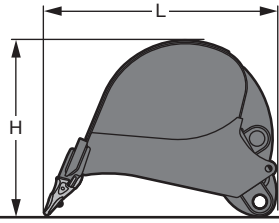

Backhoe Buckets		Std		
Cutting width	mm	1,800	1,950	2,150
Capacity	m ³	3.80	4.30	4.80
L Length	mm	2,500	2,500	2,500
H Height	mm	1,900	1,900	1,900
Width	mm	1,850	2,000	2,200
Weight	kg	4,000	4,200	4,450

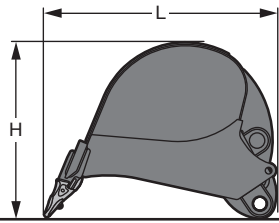

Backhoe Buckets		Std		
Cutting width	mm	2,300	2,300	2,600
Capacity	m ³	5.20	5.80	6.60
L Length	mm	2,500	2,600	2,600
H Height	mm	1,950	1,950	1,950
Width	mm	2,350	2,350	2,650
Weight	kg	4,600	4,800	5,100

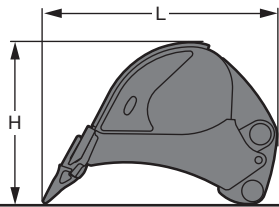

Backhoe Buckets		HD		
Cutting width	mm	1,800	1,950	2,150
Capacity	m ³	3.60	4.10	4.60
L Length	mm	2,450	2,450	2,450
H Height	mm	1,950	1,950	1,950
Width	mm	1,850	2,000	2,200
Weight	kg	4,400	4,750	5,050

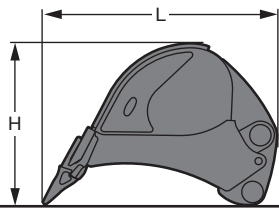

Backhoe Buckets		HD		
Cutting width	mm	2,300	2,300	2,400
Capacity	m ³	5.20	5.60	6.20
L Length	mm	2,450	2,550	2,550
H Height	mm	1,950	1,950	1,950
Width	mm	2,350	2,350	2,450
Weight	kg	5,400	5,550	5,900

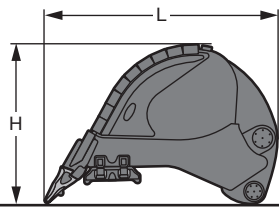

Backhoe Buckets		HDV			
Cutting width	mm	1,950	2,150	2,300	2,300
Capacity	m ³	4.20	4.70	5.20	5.70
L Length	mm	2,450	2,450	2,450	2,600
H Height	mm	1,950	1,950	1,950	1,950
Width	mm	2,000	2,200	2,350	2,350
Weight	kg	5,250	5,550	5,850	6,400

Component Dimensions and Weights

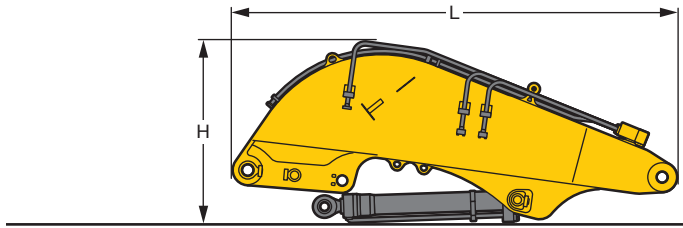

Shovel Boom

L	Length	mm	4,950
H	Height	mm	2,050
	Width	mm	1,650
	Weight without crowd cylinder	kg	7,300
	Weight crowd cylinder	kg	2 x 450

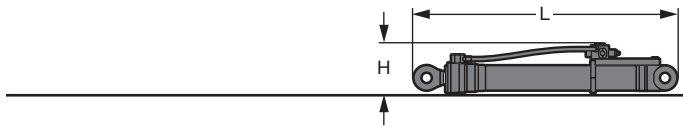

Shovel Hoist Cylinders (two)

L	Length	mm	2,920
H	Height	mm	550
∅	Diameter	mm	450
	Weight	kg	2 x 1,100

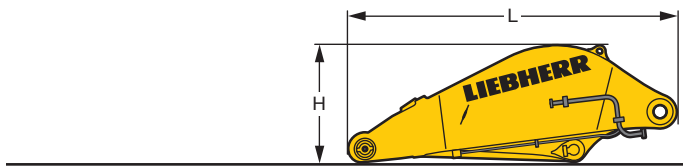

Shovel Stick

L	Length	mm	3,660
H	Height	mm	1,300
	Width	mm	1,800
	Weight	kg	4,650

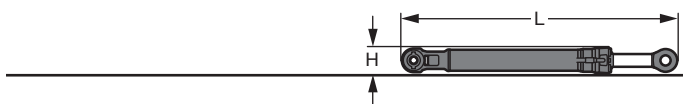

Shovel Bucket Cylinders (two)

L	Length	mm	3,050
∅	Diameter	mm	300
	Weight	kg	2 x 625

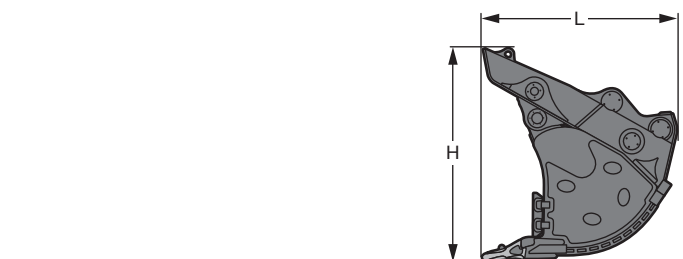

Front Shovels

Cutting width	mm	2,300	2,700	2,000	2,000	
Capacity	m ³	4.40	5.10	5.40	5.60	
L	Length	mm	2,600	2,600	2,500	2,800
H	Height	mm	2,600	2,600	2,700	2,600
	Width	mm	2,350	2,750	2,750	2,750
	Weight					
	Level I	kg	-	8,450	-	8,750
	Level II	kg	8,300	9,100	-	9,450
	Level III	kg	9,150	10,150	9,900	-

Standard Equipment



Undercarriage

Lashing eyelets
Lifetime-lubricated track rollers
Track guide at each track frame (three pieces)
Tracks sealed and greased



Uppercarriage

Engine hood with lift help
Extended tool kit
Fuel tank cap, lockable
Handrails, non slip surfaces
Maintenance-free swing brake lock
Sound insulation
Toolbox lockable
Walkway, both-sided



Hydraulic System

Filter with integrated fine filter area
Hydraulic tank shut-off valve and pumps
Liebherr hydraulic oil
Pressure storage for controlled lowering of equipment with engine turned off
Pressure test ports for hydraulic
Stepless work mode selector



Engine

After-cooled
Common-Rail system injection
Conform with stage IIIA/Tier 3 emission standard
Dry-type air cleaner w/pre-cleaner, main and safety elements
Engine cold starting aid
Fuel filter and water separator
Sensor-controlled automatic engine idling
Turbo charger



Operator's Cab

7" colour multifunction display with touchscreen
All tinted windows
Automatic air conditioning
Cigarette lighter and ashtray
Coat hook
Cup holder
Dome light
Door with sliding windows
Emergency exit rear window
Fuel consumption indicator
Hydro mounts
Impact-resistant front window and roof window
LiDAT Plus (enhanced Liebherr data transfer system)*
Mechanical hour meters, readable from outside the cab
Operator seat Liebherr-Comfort
Preparation for radio installation
Rain hood over front window opening
Rear space monitoring with camera
Roll-down sun blind
Rubber floor mat
Seat belt
Storage bin
Storage space
Two headlights (Halogen)
Wiper/washer



Attachment

Headlights on boom (both-sided, halogen)
Liebherr full-automatic central lubrication system (except connecting link for bucket kinematics)
Re-Generation plus
Safety check valves hoist cylinder
Safety check valves stick cylinder

* optionally extendable after one year

Individual Options



Undercarriage

- Cover and base protection plates
- Protection plate for wrecking ball operation
- Track guide at each track frame (four pieces)
- Travel drive protection
- Travel gear support, reinforced



Uppercarriage

- Cab elevation
- Headlights with protection
- Heavy counterweight
- Refuelling pump (electrical)
- Rock protection (swing gear and lubrication pipes)
- Walkway, wide version with guard rail
- Wiggins quick-coupling for fuel



Hydraulic System

- Bypass filter
- Liebherr hydraulic oil, specially for warm and cold regions
- Pre-heating for hydraulic oil



Engine

- Automatic engine shut-down (adjustable time-period)
- Engine compartment light
- Pre-heating for fuel, coolant and engine oil



Operator's Cab

- Additional headlights front or/and rear (Halogen or LED)
- Amber beacon
- Auxiliary heater (programmable)
- Camera for side area monitoring
- Electric cool box (12 V)
- Electronic drive away lock
- Engine shut-down (emergency stop) in cab
- FGPS front guard, lockable
- Fire extinguisher
- Footrest
- FOPS top guard
- Headlights (two pieces, LED)
- Operator seat Liebherr-Premium
- Proportional controls Liebherr
- Radio Comfort
- Roof wiper
- Sun visor
- Travel alarm system



Attachment

- Automatic lubrication system for connecting link
- Bottom boom protection for stick
- Headlights on boom (both-sided, LED)
- High pressure circuit
- Hydraulic or mechanical quick coupler
- Liebherr line of buckets
- Liebherr tooth system
- Middle pressure circuit
- Overload warning device
- Piston rod guard for bucket cylinder
- Piston rod guard for crowd cylinder
- Piston rod guard for hoist cylinder
- Security for hoist cylinder in grab or hammer operation

Options and/or special attachments, supplied by vendors other than Liebherr, are only to be installed with the knowledge and approval of Liebherr in order to retain warranty.